

EXPLANATIONS
ALL MEASURES ARE IN MILLIMETRES

NOTES
THE SLIDING WINDOW SHALL BE SVALSON SLIDING WINDOW
TYPE SV FIRE RESISTANT CLASS E-60
SVALSON AB, SWEDEN (+46 911-667 25).

CONSTRUCTION
MOTOR, TRANSMISSION AND AUTOMATIC
LOCKING SHALL BE PLACED WITHIN THE FRAME.

LOCKING
WINDOW SHALL BE LOCKED AUTOMATICLY IN
CLOSED POSITION AND THROUGH ALL OPENING
WITH 50mm INTERVAL.

FINISH
STEELPROFILES WILL BE POWDERCOATED I RAL
OR NCS-COLOR.

GLASS
6mm PYRAN S.

OPENINGSPEED
THE OPENINGSPEED OF THE
SLIDING WINDOW IS APPROX.
200 mm/SECOND.

REV	REVISION REFERES TO	DATE	SIGN
-----	---------------------	------	------



SVALSON AB
Phone +46 911-66725
Telefax +46 911-66680
http://www.svalson.com

Box 584
S-943 28 Öjebyn
SWEDEN

SLIDING WINDOW TYPE SV E-60		VIEW FROM OUTSIDE	<input checked="" type="checkbox"/>
DRAWN/DESIGN	SCALE	VIEW FROM INSIDE	<input type="checkbox"/>
---	1:10		
DATE	DRAWING NUMBER	REV	
DD.MM.YY	SV E-60. A		

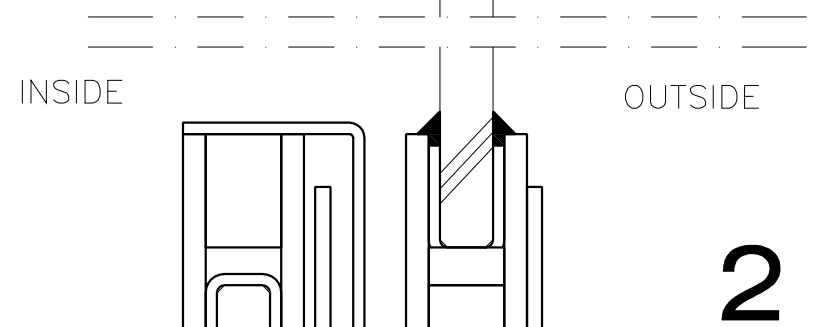
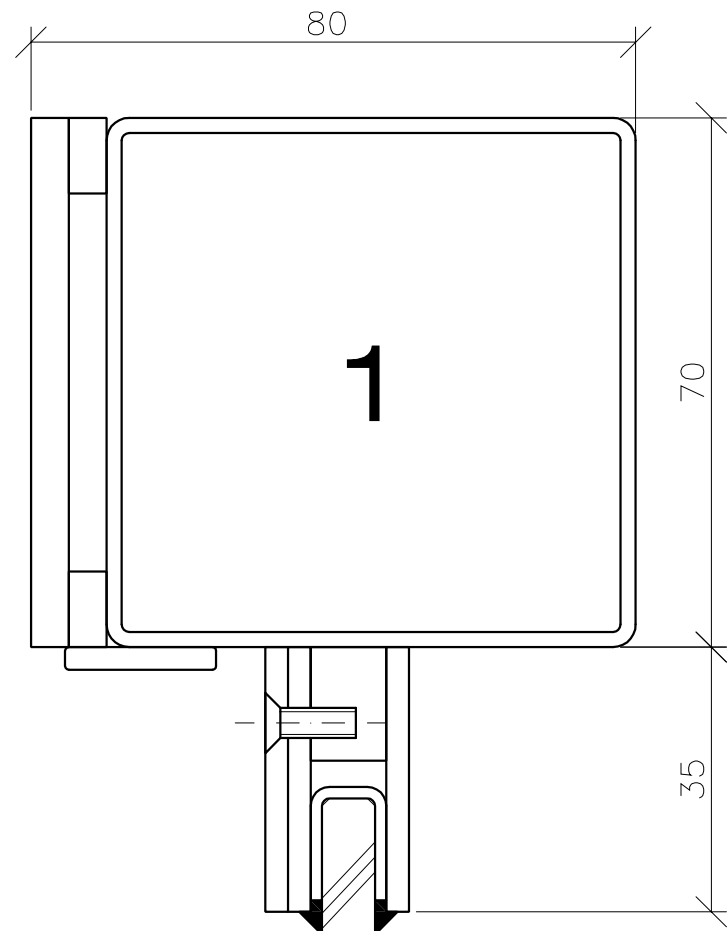

FIRERESISTANT SILICONE



FIBERFRAX

FIBERFRAX

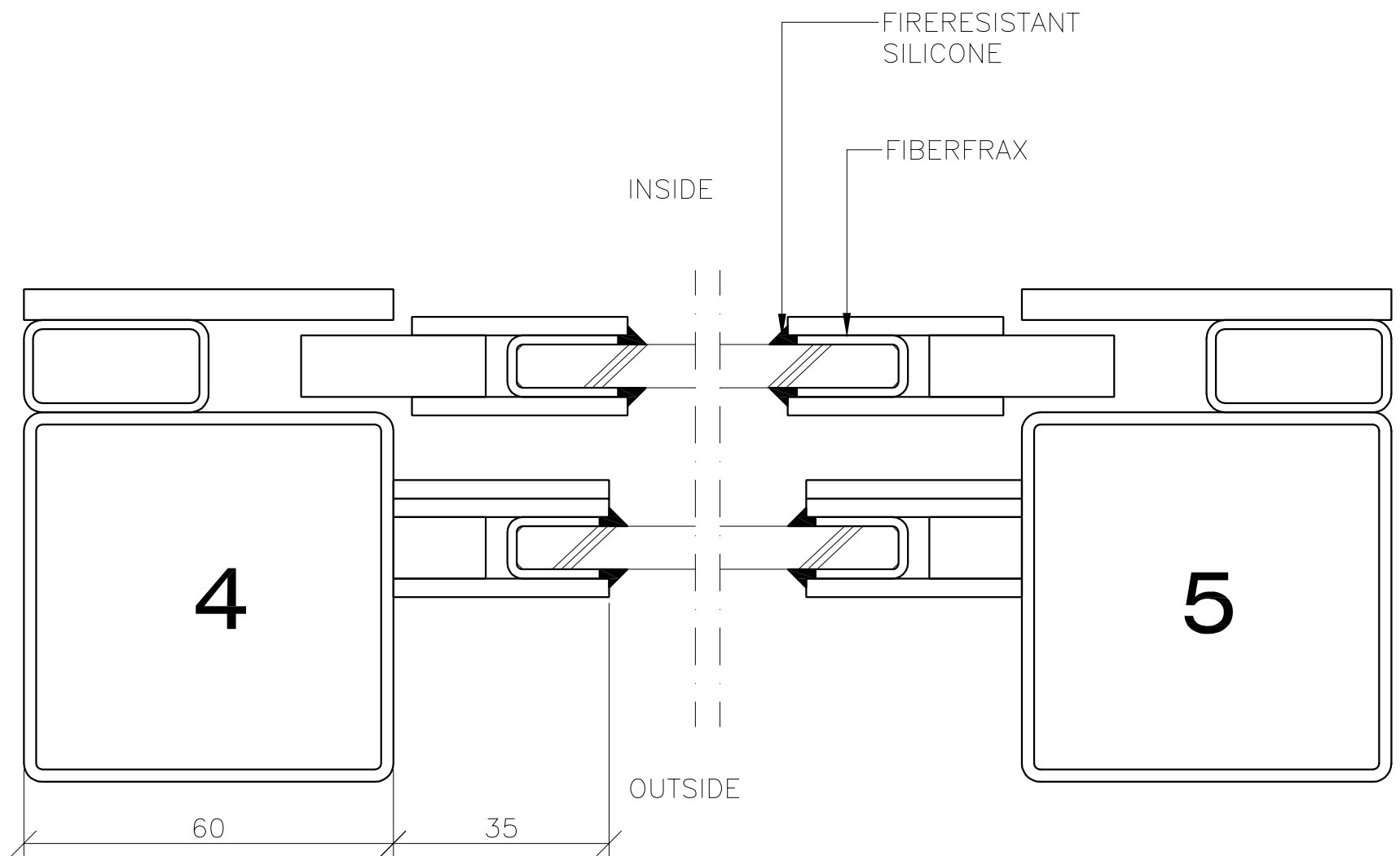
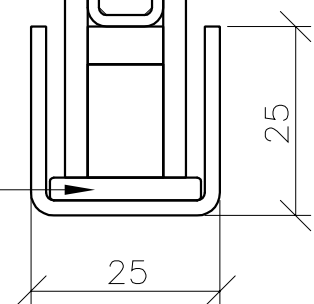

FIRERESISTANT SILICONE

FIBERFRAX

INSIDE

OUTSIDE



SVALSON AB
 Phone +46 911-66725
 Telefax +46 911-66680
 http://www.svalson.com

Box 584
 S-943 28 Öjebyn
 SWEDEN

REV	REVISION REFERES TO	DATE	SIGN

SLIDING WINDOW
TYPE SV E-60

DRAWN/DESIGN	SCALE	VIEW FROM OUTSIDE	VIEW FROM INSIDE
---	1:1		
DATE	DRAWING NUMBER	REV	
DD.MM.YY	SV E-60. B		

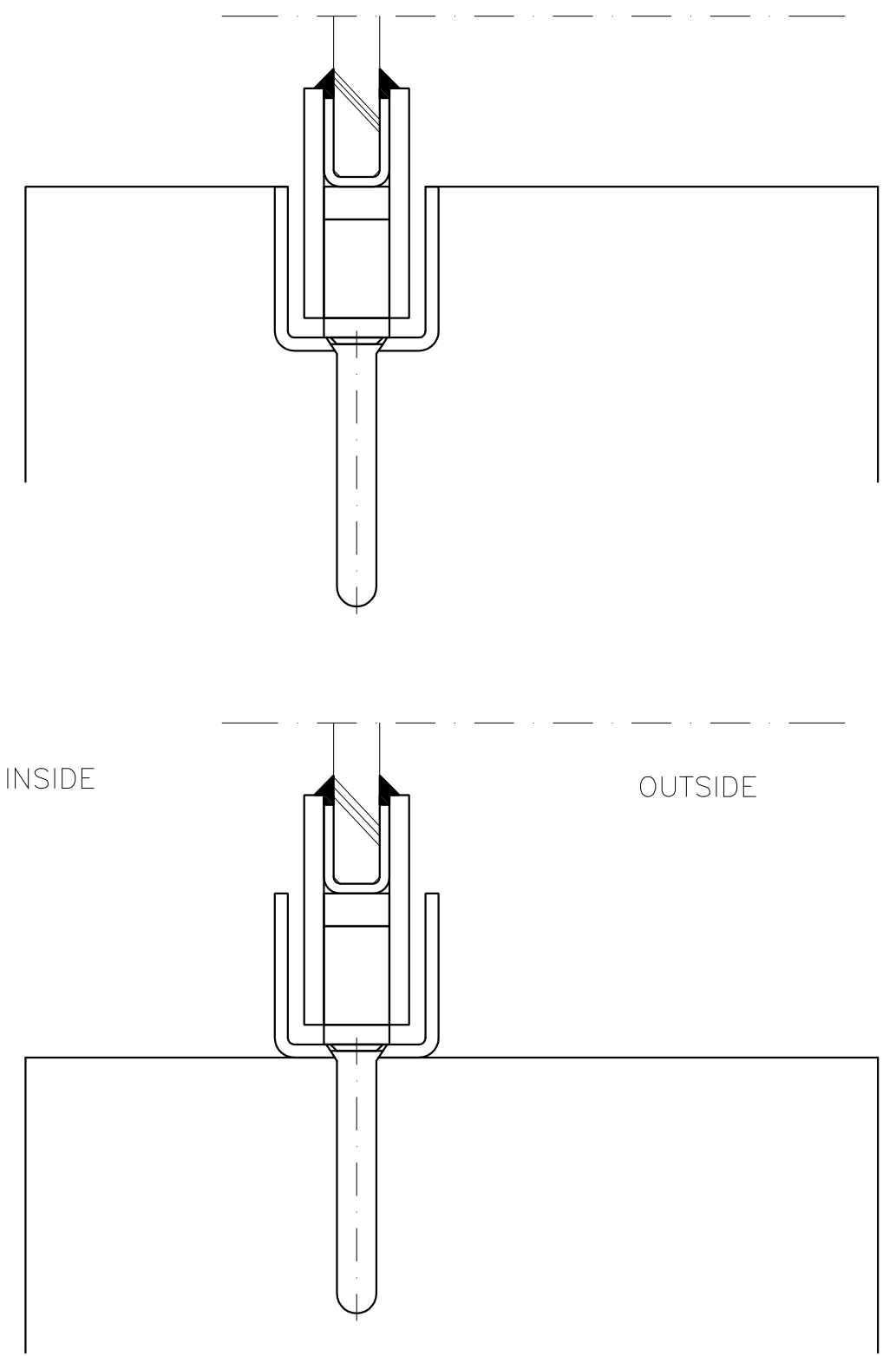
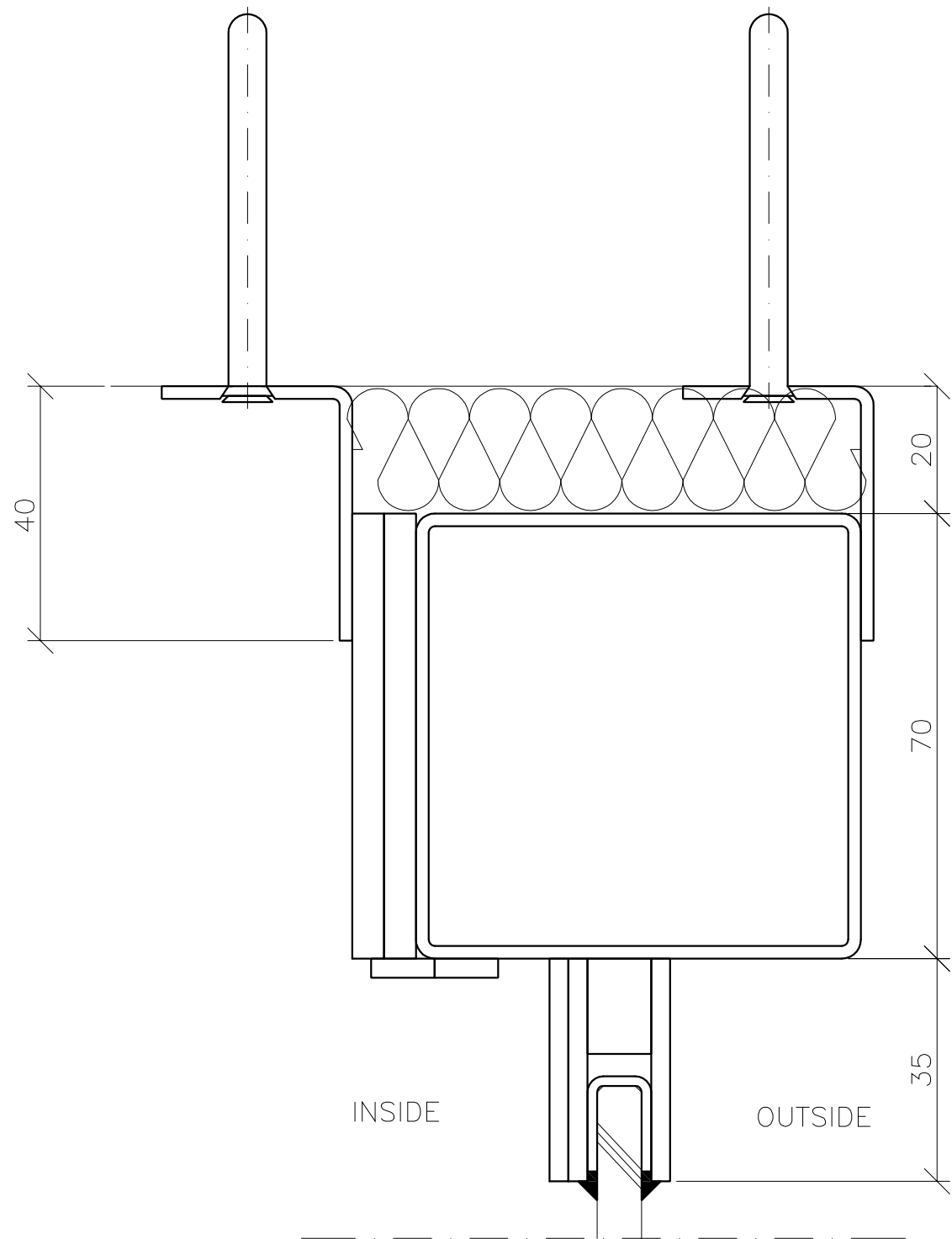

REV	REVISION REFERES TO	DATE	SIGN



SVALSON AB
 Phone +46 911-66725
 Telefax +46 911-66680
 http://www.svalson.com

Box 584
 S-943 28 Öjebyn
 SWEDEN

SLIDING WINDOW TYPE SV E-60		VIEW FROM OUTSIDE	<input checked="" type="checkbox"/>
DRAWN/DESIGN --	SCALE 1:1	VIEW FROM INSIDE	<input type="checkbox"/>
DATE DD.MM.YY	DRAWING NUMBER SV E-60. C	REV	<input type="checkbox"/>

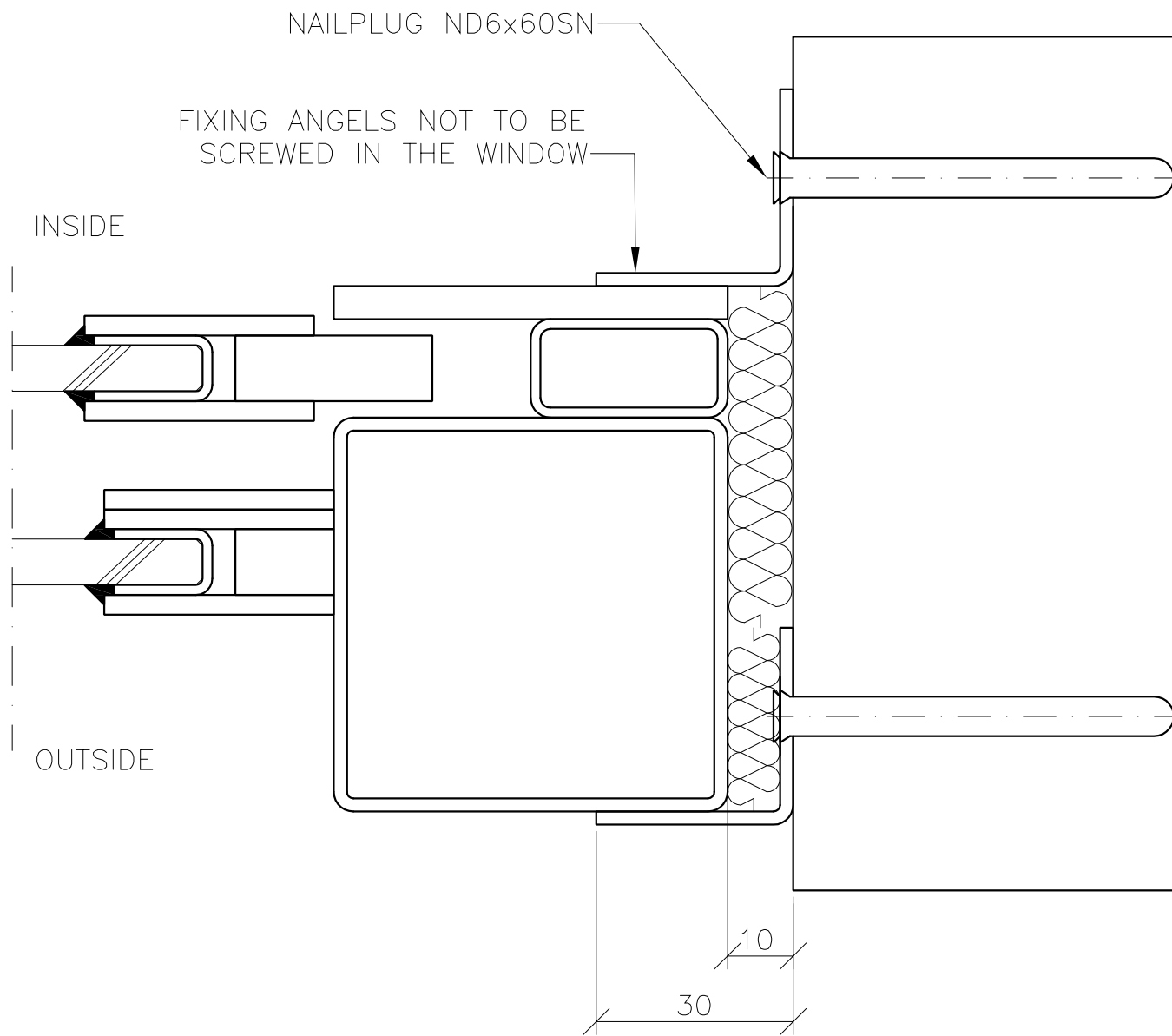

REV	REVISION REFERES TO	DATE	SIGN
-----	---------------------	------	------



SVALSON AB
 Phone +46 911-66725
 Telefax +46 911-66680
 http://www.svalson.com

Box 584
 S-943 28 Öjebyn
 SWEDEN

SLIDING WINDOW TYPE SV E-60		VIEW FROM OUTSIDE	<input checked="" type="checkbox"/>
DRAWN/DESIGN --	SCALE 1:1	VIEW FROM INSIDE	<input type="checkbox"/>
DATE DD.MM.YY	DRAWING NUMBER SV E-60. D	REV	